

Florida

Floodplain Management Performance Measures

*Helping Communities Remain Compliant
with the NFIP and Retain CRS Points*



FLOODPLAIN MANAGEMENT PERFORMANCE MEASURES

2018

Bureau of Mitigation

Florida Division of Emergency Management



STATE OF FLORIDA

DIVISION OF EMERGENCY MANAGEMENT

RICK SCOTT
Governor

WESLEY MAUL
Director

DATE: January 15, 2018

TO: Florida NFIP-Participating Communities

FROM:  Steve Martin, State NFIP Coordinator / State Floodplain Manager
Bureau of Mitigation

SUBJECT: *Floodplain Management Performance Measures for NFIP Compliance*

The Florida Division of Emergency Management is pleased to assist Florida communities with ensuring that their floodplain management procedures are compliant with the NFIP and to help ensure that they do not lose Community Rating System (CRS) credit points. The CRS program helps communities improve flood resiliency and rewards them by offering discounts on flood insurance premiums.

During the past couple of years, the Bureau, FEMA and the Insurance Services Office (ISO) collaborated on a unique *CRS-CAV Pilot Program* aimed at helping communities participate in CRS. Communities must first demonstrate that they have an NFIP-compliant program. Communities currently participating in CRS may lose points if they do not fully enforce their floodplain regulations. These Performance Measures, when implemented, will help ensure communities do not lose CRS credit points, retrograde, or worse, experience FEMA or State enforcement actions for failing to comply with the more frequently observed NFIP compliance issues.

We strongly encourage all communities in Florida to adopt these Performance Measures by resolution, using the example copy enclosed. Adoption of these performance measures accomplishes two important objectives. One, it helps reconnect local policy makers and administrators with some of the basic NFIP regulatory requirements in the local flood ordinance that community staff must enforce. And, two, it affirms that leaders do support community staff activities to enforce the local flood ordinance which is required for communities to participate in the NFIP.

The State Floodplain Management Office (SFMO) stands ready to assist local staff with implementing community floodplain management programs to help ensure flood resilient communities. The SFMO team is readily accessible to provide technical support regarding any NFIP matter. Please contact the SFMO staff 850.815.4556 or at our Floods email account at: Floods@em.myflorida.com for further information.

To visit our SFMO web pages, please go the Bureau of Mitigation's website:
<https://www.floridadisaster.org/dem/mitigation/>.

SM/

Table of Contents

Floodplain Management Performance Measures.....	1
Florida CRS Initiative Flowchart.....	2
Draft Resolution to Adopt and Implement Performance Measures.....	3
Summary of Floodplain Management Performance Measures.....	5
<u>Performance Measure 1</u>	7
Adopt State Model Flood Damage Prevention Ordinance	
<u>Performance Measure 2</u>	9
Conduct annual inspections in SFHAs, resolve compliance matters and annually report findings	
<u>Performance Measure 3</u>	15
Adopt and implement a flood zone permit application to regulate development in flood zones with procedures and checklists	
<u>Performance Measure 4</u>	33
Verify accurate completion of all Elevation Certificates before vertical construction and prior to issuance of certificates of occupancy	
<u>Performance Measure 5</u>	35
Disseminate letters annually to utility companies on tanks that must be elevated or anchored, and mechanical (HVAC) equipment that must be elevated above the Base Flood Elevation (BFE)	
<u>Performance Measure 6</u>	47
Develop and implement “Substantial Improvement/Substantial Damage” determination procedures approved by State and retain permanent records of determinations	
<u>Performance Measure 7</u>	61
On community websites, where feasible, provide digital Flood Insurance Rate Maps (DFIRMs) and Elevation Certificates (ECs) or links to DFIRMS and ECs	



State Floodplain Management Office (SFMO)

Floodplain Management Performance Measures

What are the *Floodplain Performance Measures*?

Minimum requirements in the form of guidance and templates or “best floodplain management practices” that NFIP-participating and CRS communities should implement to ensure they do not become non-compliant, or lose credit points or retrograde in CRS.

Five performance standards focus on meeting the minimum NFIP requirements:

- 1) inspect floodplains annually,
- 2) use of floodplain permit application forms provided,
- 3) verify accuracy of ECs,
- 4) proactively send letters to tank and HVAC companies explaining the need to elevate or anchor equipment, and
- 5) conduct SI/SD determinations based on the SI/SD Desk Reference (P-758).

The other two measures concern adoption of state model flood ordinance that is coordinated with the Florida Building Code and posting ECs on local websites.

Why does the State promote them, and why should communities adopt them?

- To ensure that Florida communities consistently meet the minimum NFIP requirements.

Who developed them, and are they mandatory?

- The *Floodplain Performance Measures* were developed by the SFMO in consultation with national experts in the floodplain management under the NFIP.
- The *Floodplain Performance Measures* are not mandatory but they that help communities meet minimum NFIP requirements much like FEMA Bulletins and Guidance documents. When communities’ governing boards adopt Measures by Resolution, it shows commitment to support staff that implement floodplain management.

Communities may download and adopt by resolution, and request further information.

- Communities may request copies in Word so they may tailor them to specific community needs, or in fillable PDF formats, by calling the SFMO at **850.815.4556** or by emailing: **floods@em.myflorida.com**.

Florida CRS Initiative

Pilot Program to Enroll Communities in the Community Rating System

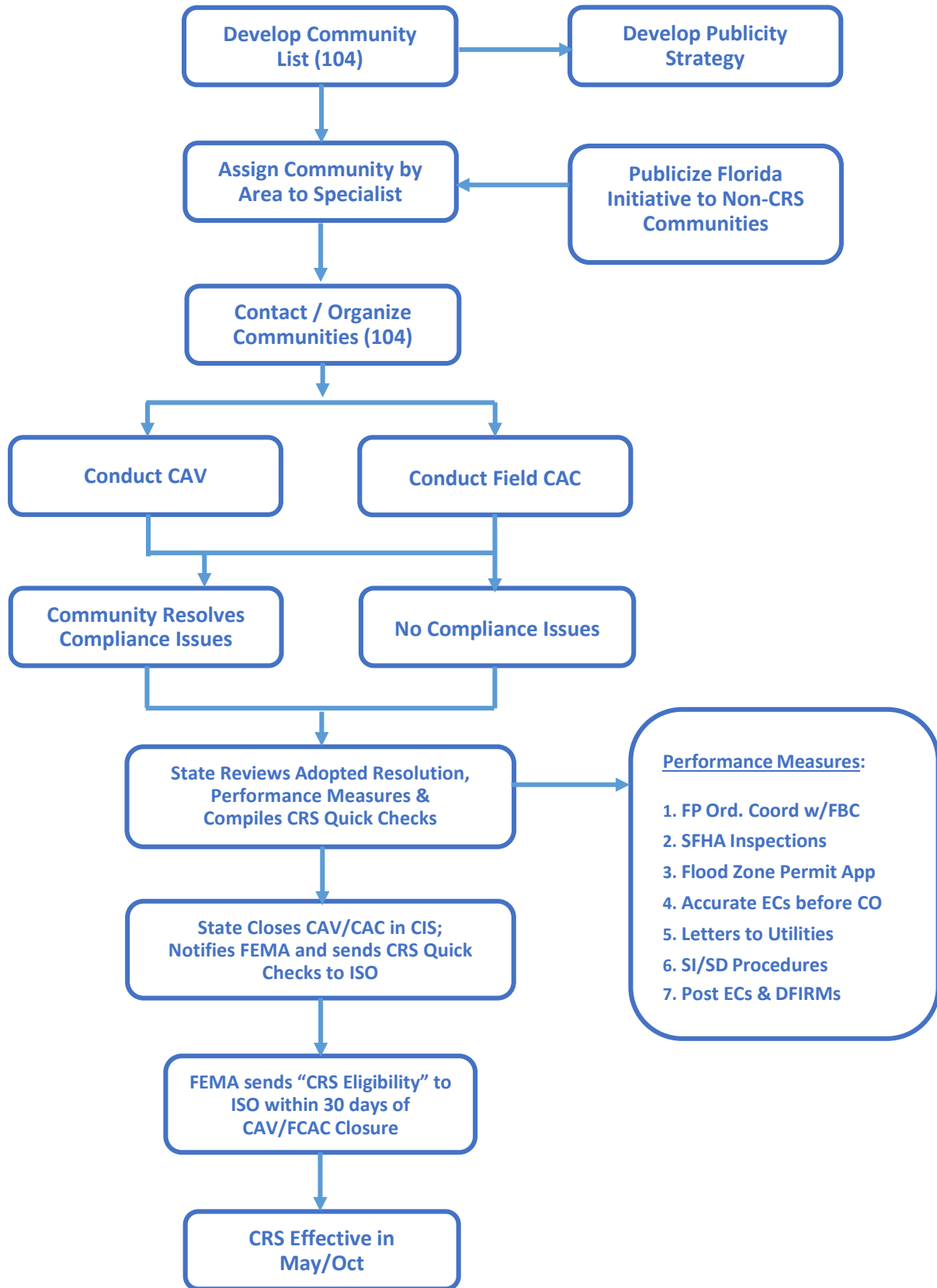

COMMUNITY SEAL, ADDRESS

RESOLUTION TO IMPLEMENT PERFORMANCE MEASURES

FOR COMPLIANCE WITH THE NATIONAL FLOOD INSURANCE PROGRAM

WHEREAS, the (*COMMUNITY*) has been a National Flood Insurance Program (NFIP) participant in good standing since (*DATE OF REGULAR ENROLLMENT*) , and seeks to maintain and improve its flood resiliency through the NFIP and Community Rating System (CRS); and,

WHEREAS, (*COMMUNITY*) has designated special flood hazard areas on NFIP flood insurance rate maps that were adopted on *DATES OF CURRENT FIRMs*, and the community has *NUMBER OF POLICIES* ; and,

WHEREAS, the (*COMMUNITY*) has reviewed and re-dedicated itself to meeting all requirements for joining the NFIP that it adopted by Resolution when it first joined the voluntary NFIP; and,

WHEREAS, the (*COMMUNITY*) re-dedicates itself to be compliant with the NFIP subject to determination by the Florida Division of Emergency Management and/or the Federal Emergency Management Agency (FEMA) by virtue of a determination through a *SELECT A CONTACT TYPE* that the community has an NFIP-compliant floodplain management program; and,

WHEREAS, the (*COMMUNITY*) has developed and is actively implementing “Performance Measures” to ensure that its floodplain management program meets or exceeds the minimum requirements of the NFIP; and,

WHEREAS, it is the intent of this (*COUNCIL or COMMISSION*) to continue participation in the CRS program and strive to exceed the minimum NFIP requirements set forth in Parts 59, 60, and 65 of the National Flood Insurance Program Regulations (Title 44 of the Code of Federal Regulations);

NOW, THEREFORE, BE IT RESOLVED that this (*COUNCIL, or COMMISSIONERS*) hereby:

Assures the State of Florida, Division of Emergency Management and the Department of Homeland Security’s Federal Emergency Management Agency (FEMA), that it will enact as necessary, and maintain in force in those areas having flood, or flood-related hazards, adequate land use and floodplain regulations with effective enforcement provisions necessary to implement an NFIP-compliant program and to implement the performance measures required to ensure consistency with the NFIP and CRS program as referenced and incorporated herein; and

Vests the (*COMMUNITY*) floodplain administrator and his/her associates with the responsibility, authority and means to implement the following performance measures which are incorporated

by reference and attached:

- (1) Adopt and maintain a flood damage prevention ordinance based on the State model that is coordinated with the Florida Building Code,
- (2) Conduct annual inspections of development in SFHAs to be reported annually that addresses identified compliance issues to be resolved through enforcement and mitigation to the maximum extent possible,
- (3) Administer a flood zone permit application for regulating all development in SFHAs with procedures and checklists approved by the State and FEMA Region IV,
- (4) Ensure accurate completion of all elevation certificates before vertical construction and prior to issuance of certificates of occupancy,
- (5) Annually disseminate letters to utility companies concerning tanks that must be elevated or anchored and new HVAC equipment that must be elevated above the BFE,
- (6) Administer substantial improvement/damage determination procedures approved by State and FEMA Region IV staff and maintenance of permanent records of determinations,
- (7) Provide DFIRMs or links to DFIRMs and elevation certificates on the community's website where feasible.

The (*COMMUNITY*) also agrees to take such other official action as may be reasonably necessary to carry out the objectives of the NFIP and CRS programs.

Adopted on _____, 20____, by the _____
(*COMMUNITY GOVERNING BODY*).

By: _____
_____, Title of Elected Official
Name

Certified By: _____ SEAL
_____, Clerk
Name

Seven Performance Measures

That Must be Adopted to Enroll in CRS Under the Pilot Program

<https://www.floridadisaster.org/dem/mitigation/>

Performance Measure 1: Adopt State model flood damage prevention ordinance coordinated with the Florida Building Code and provide evidence that floodplain staff coordinate with the building official;

Performance Measure 2: Conduct annual inspections of development in special flood hazard areas and annually report identified compliance issues resolved through enforcement and mitigation to the maximum extent possible;

Performance Measure 3: Adopt and implement a flood zone permit application for regulating all development in special flood hazard areas with procedures and checklists approved by State and FEMA Region IV staff for use by the community;

Performance Measure 4: Verify accurate completion of all Elevation Certificates before vertical construction and prior to issuance of certificates of occupancy;

Performance Measure 5: Disseminate letters annually to utility companies concerning tanks that must be elevated or anchored, and heating, ventilation and air conditioning (HVAC) equipment that must be elevated above the Base Flood Elevation (BFE);

Performance Measure 6: Develop and implement “Substantial Improvement/Substantial Damage” determination procedures approved by State and Region IV staff and retention of permanent records of determinations; and,

Performance Measure 7: On community websites, where feasible, provide digital Flood Insurance Rate Maps (DFIRMs) and Elevation Certificates (ECs), or links to DFIRMS and ECs



Performance Measure 1

Adopt State Model Flood Damage Prevention Ordinance

To access and download Frequently Asked Questions, Instructions and Notes, and the fillable draft State Model flood damage prevention ordinances for communities with Zones A and V, and for communities with Zones A only click on:

<https://www.floridadisaster.org/dem/mitigation/>

Local Ordinance & Building Code Resources

Please review pertinent materials on this page for your local ordinance needs. After reviewing them, if you have questions or need further guidance, please email us at Flood.Ordinance@em.myflorida.com.

UPDATED! [Frequently Asked Questions](#)

Is action required? Are we required to use the FBC-coordinated model ordinance? Will DEM review our existing regulations for sufficiency? What are the most common mistakes communities make when working with the model? What about higher standards? And many more!

Local Ordinance Adoption Resources Final January 15, 2013 Documents

IMPORTANT: Use <track changes> to tailor the model ordinance for you community and send it to Flood.Ordinance@em.myflorida.com well in advance of your first reading.

- ▣ Communities with Both Zones A and Zones V
 - ▣ [Instructions and Notes](#)
 - ▣ [Model Ordinance and Code Amendments](#)
- ▣ Communities with Only Zones A
 - ▣ [Instructions and Notes](#)
 - ▣ [Model Ordinance and Code Amendments](#)
- ▣ [NFIP Checklist](#) (Comparing Model to NFIP Regulations)
- ▣ [FEMA Approval of State Model Ordinance](#)



Performance Measure 2

**Conduct Annual Inspections in SFHAs, Resolve Compliance Matters
and Annually Report Findings**

FLOOD ZONES INSPECTIONS FORM

ANNUAL REPORT

*Retain original with your CRS records
and submit as part of annual
recertification report.*

Community Information	
Community Name:	County Name:
Date(s) of inspection:	Date of last inspection:
Name and Title of Lead Person Inspecting Flood zones:	
Email:	Phone:
Other inspectors:	Time Allocated for Inspections: (hours)
Ordinance Citation:	Date of most recent amendments:
Name and Title of Designated Floodplain Administrator:	
Email:	Phone:
FIRM Date:	Panel Numbers:
Flood Zones on FIRM:	
<input type="checkbox"/> Zone A/AE <input type="checkbox"/> Zone AO/AH <input type="checkbox"/> Zone V/VE <input type="checkbox"/> CAZ/LiMWA <input type="checkbox"/> Floodway <input type="checkbox"/> Other _____	
Higher Standards:	Describe Areas of Community Inspected: List neighborhoods, quadrants of community, water features or flood prone areas inspected:
Freeboard: <input type="checkbox"/> No <input type="checkbox"/> Yes (___ ft)	
Cumulative SI: <input type="checkbox"/> No <input type="checkbox"/> Yes (___ yrs)	
Enclosure Limits: _____(describe)	
Other: _____(describe)	
Inspection Summary	
<input type="checkbox"/> Flood maps appear inaccurate (describe):	
<input type="checkbox"/> Evidence of flooding since last inspection (describe):	
<input type="checkbox"/> Attached Address Inspection Forms	
Number of unpermitted development: _____ structures _____	
Number of development issues resolved: _____ Number of structure issues resolved: _____	
Number of unresolved development issues: _____ Number of structure issues un resolved: _____	

Property Information		
Date:	Community Name:	Community ID:
Address:	Type of Development:	
Visual Description of Property:		
Flood Zone:	FIRM Map Date:	FIRM Panel #

Requirement	Yes	No	N/A
Approx A-ZONE: Is the foundation 2' above lowest adjacent grades?			
AE-ZONE: Is the lowest floor elevated, or is non-residential or historic structures Floodproofed to or above the BFE?			
Regulatory Floodway: If structures are located in floodway, check permit files for No-Rise Determinations			
Are electrical and mechanical equipment above BFE?			
Are there flood openings no more than 1' above lowest adjacent grades?			
Are there enclosed areas below the BFE?			
Are areas below the BFE used solely for parking, access, or storage?			
Is there an attached garage below residential finished floor with flood openings no more than 1' above lowest adjacent grade?			
Was fill used to elevate home in A or AE zones?			
NON-RESIDENTIAL: Is the structure floodproofed?			
V-ZONE: Is the bottom of the lowest horizontal structural member of the lowest floor above the BFE?			
V-ZONE: Are enclosures below the lowest floor constructed with breakaway walls or left open?			
Notes:			
Photos taken: Y N Number _____			



Performance Measure 3

Adopt and implement a flood zone permit application form for regulating all development in special flood hazard areas with procedures and checklists

SPECIAL FLOOD HAZARD AREA

DEVELOPMENT APPLICATION

for all development not subject to the Florida Building Code (including buildings and facilities exempt from the FBC)

Permit/Approval Number:		
<p>Identify the Proposed Development, check all that apply:</p> <p>Filling <input type="checkbox"/> Grading <input type="checkbox"/> Road, Watercourse Crossing, Paving <input type="checkbox"/> Excavation <input type="checkbox"/> Drilling <input type="checkbox"/> Mining <input type="checkbox"/> Nonresidential farm building on farm <input type="checkbox"/> Temporary building or shed for construction <input type="checkbox"/> Manufactured Home <input type="checkbox"/> Equipment Storage <input type="checkbox"/> Materials Storage <input type="checkbox"/> Tank Installation <input type="checkbox"/> Water or sewer system <input type="checkbox"/> Other site improvements/utilities <input type="checkbox"/> Placement of Recreational Vehicle <input type="checkbox"/> Fence, wall, sidewalk, driveway, deck, walkway, patio <input type="checkbox"/> Pool <input type="checkbox"/> Watercourse Alteration <input type="checkbox"/> Other <input type="checkbox"/> _____</p> <p>NOTE: Buildings and structures associated with this development application must be separately permitted under the FBC; use the appropriate <i>Special Flood Hazard Area Building Permit Application Supplement</i>.</p>		
<p>Describe proposed development:</p> <p>Site plan attached? Yes <input type="checkbox"/> No <input type="checkbox"/> Must show extent of area impacted by proposed development, flood hazard area boundaries and flood zones, BFE, existing and proposed ground elevations as applicable to the development, and existing buildings.</p> <p>Subdivision or proposal with more than 5 acres or more than 50 lots? Yes <input type="checkbox"/> No <input type="checkbox"/> If yes, and if SFHA has no BFE, see XXX.</p> <p>For nonresidential farm buildings on farms, temporary buildings or sheds for construction, and manufactured homes, complete and attach the Building Permit Application Supplement for New Construction. Attached? Yes <input type="checkbox"/> No <input type="checkbox"/></p>		
Property Address:	Owner Name & Address: Agent Name:	Cost of Proposed Work: \$
Section:	Township:	Range:
Lot:	Block:	Subdivision:
Contractor Name:	Contractor Address:	Contractor Phone:
Associated Building Permit Application Number, if applicable:		
FIRM Panel Number:	FIRM Panel Date:	
Flood Zone Designation: _____ In Floodway? Yes <input type="checkbox"/> No <input type="checkbox"/> <i>If yes, encroachment analysis required.</i> In CAZ/seaward of LiMWA? Yes <input type="checkbox"/> No <input type="checkbox"/> <i>If yes, determine if regulated as Zone V.</i> Seaward of CCCL? Yes <input type="checkbox"/> No <input type="checkbox"/> <i>If yes, require DEP permit.</i> In CoBRA or OPA? Yes <input type="checkbox"/> No <input type="checkbox"/> <i>If yes, Federal flood insurance is not available.</i>	Base Flood Elevation: _____ feet _____ datum How determined? FIRM <input type="checkbox"/> FIS Water Surface Elevations <input type="checkbox"/> Unnumbered A Zone* <input type="checkbox"/> (BFE = 2 ft above grade unless evidence indicates deeper) Applicant Prepared Flood Study (attached) <input type="checkbox"/> FEMA Letter of Map Change (attached) <input type="checkbox"/> Additional Community Flood Hazard Data? Yes <input type="checkbox"/> No <input type="checkbox"/>	
If Compensatory Storage locally adopted , is evidence of compensation attached? Yes <input type="checkbox"/> No <input type="checkbox"/> Not adopted <input type="checkbox"/>		

Agreement by Owner or by Owner's Agent:

The undersigned hereby makes application to develop in a special flood hazard area. The development to be performed is described above and attached hereto. The undersigned agrees that all such work shall be done in accordance with the requirements of the local floodplain management ordinance and with all other applicable local, State and Federal regulations, including the *Florida Building Code*.

Date: _____

Signature: _____

SPECIAL FLOOD HAZARD AREA

DEVELOPMENT PLAN REVIEW CHECKLIST

for all development not subject to the Florida Building Code

Permit/Approval Number:	
<p>Identify the Proposed Development, check all that apply:</p> <p>Filling <input type="checkbox"/> Grading <input type="checkbox"/> Road, Watercourse Crossing, Paving <input type="checkbox"/> Excavation <input type="checkbox"/> Drilling <input type="checkbox"/> Mining <input type="checkbox"/> Nonresidential farm building on farm <input type="checkbox"/> Temporary building or shed for construction <input type="checkbox"/> Manufactured Home <input type="checkbox"/> Equipment Storage <input type="checkbox"/> Materials Storage <input type="checkbox"/> Tank Installation <input type="checkbox"/> Water or sewer system <input type="checkbox"/> Other site improvements/utilities <input type="checkbox"/> Placement of Recreational Vehicle <input type="checkbox"/> Fence, wall, sidewalk, driveway, deck, walkway, patio <input type="checkbox"/> Pool <input type="checkbox"/> Watercourse Alteration <input type="checkbox"/> Other <input type="checkbox"/></p> <p>NOTE: Buildings and structures associated with this development application must be separately permitted under the FBC; use the appropriate <i>Special Flood Hazard Area Building Permit Application Supplement</i>.</p>	
Initial & Date	Review Steps
	<p>[See actual requirements in floodplain management ordinance; descriptions below are intended only to guide review and must not be used to determine compliance with the actual requirements.]</p> <p>Verify FIRM, flood hazard area/ floodway boundaries, base flood elevations, <u>and</u> map revisions and LOMRs issued by FEMA. Is flood hazard information in the application correct?</p> <p><input type="checkbox"/> NO, make corrections and return the application to applicant.</p> <p><input type="checkbox"/> YES, FLOODWAY. Require engineer's "no rise" analysis and supporting hydraulic data in file before continuing review.</p> <p><input type="checkbox"/> YES, in unnumbered Zone A (without BFE). Check other sources, use estimating methods, or require applicant to determine. Unless evidence of past flooding indicates otherwise, note BFE = 2 ft above grade. If parcel has more than 50 lots or is larger than 5 acres, has applicant included BFE data prepared in accordance with currently accepted engineering practice? Yes <input type="checkbox"/> No <input type="checkbox"/> If no, applicant must provide BFE.</p> <p><input type="checkbox"/> YES, in SFHA, but applicant has elevation data that shows natural site elevation above DFE. Advise applicant to obtain LOMA and submit copy for the file.</p> <p><input type="checkbox"/> YES, in shaded Zone X (500-year floodplain). Flood hazard area review not required; flood-resistance encouraged.</p> <p><input type="checkbox"/> YES, continue review.</p>
	<p>Site plan shows nature and scale of development, size and location of new construction and existing structures on the site, distances from lot lines, the established street grades and the proposed finished grades and, as applicable, flood hazard areas, floodways, LiMWA and design flood elevations. Site plans should be drawn in accordance with an accurate boundary line survey, unless waived.</p> <p><input type="checkbox"/> YES, continue review.</p> <p><input type="checkbox"/> NO, return to applicant to revise application and site plan.</p>
	<p>Can the proposed development be modified to avoid flood hazard areas?</p> <p><input type="checkbox"/> YES, explain flood hazards and make recommendations to modify proposal to minimize flood hazards and damage potential.</p> <p><input type="checkbox"/> NO, but can impacts be further minimized?</p>
	<p>Check compliance with floodplain management regulations:</p> <p>Temporary building or shed for construction anchored? <input type="checkbox"/> Yes <input type="checkbox"/> No</p> <p>Tanks elevated or anchored compliant? <input type="checkbox"/> Yes <input type="checkbox"/> No</p> <p>Pools compliant? <input type="checkbox"/> Yes <input type="checkbox"/> No</p>
	<p>Has the applicant provided copies of all necessary State and federal permits, e.g., wetlands?</p> <p><input type="checkbox"/> NO, advise applicant which agencies to contact.</p> <p><input type="checkbox"/> YES, require copies for the file.</p>
	<p>Has the applicant provided amount, type and source of fill material, and location, extent, amount and proposed grades of all filling, grading or excavation? Are fill areas minimized? If Compensatory Storage is required, is it shown on the plans?</p>

Initial & Date	Review Steps [See actual requirements in floodplain management ordinance; descriptions below are intended only to guide review and must not be used to determine compliance with the actual requirements.]
	<input type="checkbox"/> Not applicable, continue review. <input type="checkbox"/> YES, continue review. <input type="checkbox"/> NO, return to applicant to revise application.
	Has the applicant provided the extent of any proposed alteration of sand dunes or mangrove stands, an engineering analysis demonstrating the proposed alteration will not increase the potential for flood damage, and provided evidence of approval of such alteration by the Florida Dept. of Environmental Protection? <input type="checkbox"/> Not applicable, continue review. <input type="checkbox"/> YES, continue review. <input type="checkbox"/> NO, return to applicant to revise application.
	Has the applicant provided the extent of any proposed alteration of a watercourse, engineering analysis as required by the floodplain management ordinance, and evidence of notification of adjacent communities, the Florida Division of Emergency Management, State Floodplain Management Office? <input type="checkbox"/> Not applicable, continue review. <input type="checkbox"/> YES, continue review. <input type="checkbox"/> NO, return to applicant to revise application.
	<input type="checkbox"/> Record permit in log of flood hazard area permits. <input type="checkbox"/> Make sure that all necessary documents are in the file. <input type="checkbox"/> Issue Permit and transfer file to Inspections.

PERMIT APPLICATION REVIEW COMPLETED BY: _____ DATE: _____

ISSUE PERMIT approved by: _____

DENY PERMIT approved by: _____

**SPECIAL FLOOD
HAZARD AREA**

**PLAN REVIEW CHECKLIST
NEW CONSTRUCTION
(FBC, B and FBC, R)
ZONE A**

Building Permit Number:	
Initial & Date	Review Steps
	[See actual requirements in FBC; descriptions below are intended only to guide review and must not be used to determine compliance with the actual requirements in the FBC.]
	<p>Verify FIRM, flood hazard area/ floodway boundaries, base flood elevations, <u>and</u> map revisions and LOMRs issued by FEMA. Is proposal in the flood hazard area and / or floodway?</p> <ul style="list-style-type: none"> <input type="checkbox"/> YES, must comply with flood resistant provisions of the Florida Building Code. <input type="checkbox"/> YES, FLOODWAY. All residential structures (including Manufactured Housing units) must comply with ASCE 24. <input type="checkbox"/> YES, FLOODWAY. Require engineer's "no rise" analysis and supporting hydraulic data in file before continuing review. <input type="checkbox"/> YES, in SFHA without BFEs. Check other sources, use estimating methods, or require applicant to determine. If no evidence of deeper flooding, use 2 ft above grade as BFE. <input type="checkbox"/> YES, in SFHA, but applicant has elevation data that shows natural site elevation above DFE. Advise applicant to obtain LOMA and submit copy for the file. <input type="checkbox"/> YES, in Coastal A Zone (seaward of LiMWA or if designated by community; use Zone V Checklist if Zone V requirements are applied or if 6th Ed. FBC in effect). <input type="checkbox"/> YES, in 500-year floodplain. Flood hazard area review not required; flood-resistance encouraged.
	<p>Site plan shows nature of development proposal, showing to scale the size and location of new construction and existing structures on the site, distances from lot lines, the established street grades and the proposed finished grades and, as applicable, flood hazard areas, floodways, and design flood elevations; and it is drawn in accordance with an accurate boundary line survey.</p> <ul style="list-style-type: none"> <input type="checkbox"/> YES, continue review. <input type="checkbox"/> NO, return to applicant to revise application and site plan.
	<p>Can the proposed development be modified to avoid the flood hazard area?</p> <ul style="list-style-type: none"> <input type="checkbox"/> YES, explain flood hazards and make recommendations to modify proposal to minimize flood hazards and damage potential. <input type="checkbox"/> NO, but can impacts be further minimized? Reduce fill? Site on higher ground?
	<p>Has the applicant provided copies of all necessary State and federal permits, e.g., wetlands?</p> <ul style="list-style-type: none"> <input type="checkbox"/> NO, advise applicant which agencies to contact. <input type="checkbox"/> YES, require copies for the file.
	<p>Does the proposed development include installation of manufactured home or recreational vehicle, alteration of a watercourse, filling, grading, excavation, storage of equipment/materials, tank installation, land subdivision or other development activities that are not related to the structure, or structures exempt from the FBC?</p> <ul style="list-style-type: none"> <input type="checkbox"/> NO, continue review. <input type="checkbox"/> YES, Applicant to complete and submit <i>SFHA Land Development Application</i>. Reviewer to complete <i>SFHA Land Development Checklist</i>.
	<p>Are new structures proposed to be elevated to the DFE? Give applicant a blank FEMA Elevation Certificate.</p> <ul style="list-style-type: none"> <input type="checkbox"/> NO – STOP! A permit cannot be issued for non-elevated residential buildings. <input type="checkbox"/> NO, non-residential buildings may be dry floodproofed (see design documentation requirements) <input type="checkbox"/> YES, on fill. Basements into fill are <u>not</u> allowed. <input type="checkbox"/> YES, on piers, pilings, or columns. <input type="checkbox"/> YES, on solid foundation walls (see Enclosed areas below DFE).

**SPECIAL FLOOD
HAZARD AREA**

**PLAN REVIEW CHECKLIST
NEW CONSTRUCTION
(FBC, B and FBC, R)
ZONE A (continued)**

Building Permit Number:	
Initial & Date	Review Steps
	<p>Check the following for utility support systems:</p> <ul style="list-style-type: none"> <input type="checkbox"/> Electrical, mechanical, plumbing, heating / air conditioning components elevated? <input type="checkbox"/> Sanitary sewage or on-site septic designed to minimize inflow / discharge under flood conditions? <input type="checkbox"/> On-site water supply designed to minimize inflow under flood conditions? <input type="checkbox"/> Above-ground tanks are anchored / elevated? <input type="checkbox"/> Below-ground tanks are designed to resist flotation?
	<p>If new, non-residential structure is not elevated, will it be dry floodproofed?</p> <ul style="list-style-type: none"> <input type="checkbox"/> YES, non-residential building will be dry floodproofed per ASCE 24, and signed and sealed design documentation is in file. <input type="checkbox"/> NO, permit shall not be approved.
	<p>Enclosed areas below DFE (stairwells, garages, storage areas, crawl spaces, sheds)?</p> <ul style="list-style-type: none"> <input type="checkbox"/> NO, continue review. <input type="checkbox"/> YES, number, total net open area (or engineered openings) and location of flood openings shown on plan. <input type="checkbox"/> YES, plan shows acceptable use (parking, limited storage, and access). <input type="checkbox"/> YES, flood damage-resistant materials specified below DFE. <input type="checkbox"/> YES, utilities, if any, elevated at / above lowest floor.
	<ul style="list-style-type: none"> <input type="checkbox"/> Record permit in log of flood hazard area permits. <input type="checkbox"/> Make sure that all necessary documents are in the file. • • • <input type="checkbox"/> Issue Permit and transfer file to Inspections.

PERMIT APPLICATION REVIEW COMPLETED BY: _____ DATE: _____

ISSUE PERMIT approved by: _____

DENY PERMIT approved by: _____

**SPECIAL FLOOD
HAZARD AREA**

**PLAN REVIEW CHECKLIST
NEW CONSTRUCTION
(FBC, B and FBC, R)
ZONE V**

Building Permit Number:	
Initial & Date	Review Steps [See actual requirements in FBC; descriptions below are intended only to guide review and must not be used to determine compliance with the actual requirements in the FBC.]
	Is proposal in Coastal Barrier Resources Area (CoBRA) or Otherwise Protected Area? <input type="checkbox"/> NO, continue review. <input type="checkbox"/> YES, advise applicant that Federal flood insurance is not available, document to file, continue review (must comply with flood provisions).
	Verify FIRM, flood hazard area and zone boundaries, base flood elevations, <u>and</u> map revisions or LOMRs issued by FEMA. Is proposal in the Coastal Flood Hazard Area (Zone V)? <input type="checkbox"/> NO, in "Coastal A Zone" (seaward of LiMWA or in area designated CAZ); refer to Zone A checklist if community does not regulate CAZ like Zone V or if 6 th Ed. FBC not in effect). <input type="checkbox"/> NO, in Zone A inland of Zone V or riverine Zone A - use Zone A checklist. <input type="checkbox"/> YES, in Zone V, must comply with flood resistant provisions of the Florida Building Code.
	Site plan shows development proposal, showing to scale the size and location of new construction and existing structures on the site, distances from lot lines, the established street grades and the proposed finished grades and, as applicable, flood hazard areas, LiMWA, and design flood elevations; and it is drawn in accordance with an accurate boundary line survey. <input type="checkbox"/> YES, continue review. <input type="checkbox"/> NO, return to applicant to revise application and site plan.
	Is the proposed building landward of the reach of mean high water? <input type="checkbox"/> YES, continue review. <input type="checkbox"/> NO, permit shall not be approved.
	Can the proposed development be modified to avoid SFHA / Zone V or minimize exposure? <input type="checkbox"/> YES, explain flood hazards and make recommendations to modify proposal to minimize flood hazards and damage potential. <input type="checkbox"/> NO, can flood impacts be further minimized? Maximize setback from the water? Site on higher ground?
	Has the applicant provided copies of all necessary State and federal permits, e.g., wetlands, water management district, Florida Department of Health, Florida Department of Environmental Protection, coastal zone consistency? <input type="checkbox"/> NO, advise applicant which agencies to contact. <input type="checkbox"/> YES, require copies in the file.
	Will dunes or mangrove stands be altered? <input type="checkbox"/> NO, continue review. <input type="checkbox"/> YES, if applicable, require coastal zone consistency / State approval before continuing. <input type="checkbox"/> YES, require analysis for the file indicating alteration will not increase potential flood damage.
	Is a pool proposed? Design requirements in ASCE 24. <input type="checkbox"/> NO, continue review. <input type="checkbox"/> YES, not attached to the building; continue review. <input type="checkbox"/> YES, attached to the building. Continue review only if included in foundation design.

**SPECIAL FLOOD
HAZARD AREA**

**PLAN REVIEW CHECKLIST
NEW CONSTRUCTION
(FBC, B and FBC, R)
ZONE V (continued)**

Building Permit Number:	
Initial & Date	Review Steps
	<p>Are new buildings proposed to be elevated? Give applicant a blank FEMA Elevation Certificate.</p> <p><input type="checkbox"/> NO – STOP! A permit cannot be issued for non-elevated buildings.</p> <p><input type="checkbox"/> YES, on fill. STOP! Structural fill not allowed in Zone V, require redesign.</p> <p><input type="checkbox"/> YES, on pilings or columns; signed and sealed design certification submitted?</p> <p><input type="checkbox"/> YES, on shear walls (high-rise only if required for lateral loads). Are shearwalls oriented to minimize obstruction of floodwaters? Signed and sealed design certification submitted?</p>
	<p>Check the following for utility support systems:</p> <p><input type="checkbox"/> Electrical, mechanical, plumbing, heating / air conditioning components elevated?</p> <p><input type="checkbox"/> Sanitary sewage or on-site septic designed to minimize inflow / discharge under flood conditions?</p> <p><input type="checkbox"/> On-site water supply designed to minimize inflow under flood conditions?</p> <p><input type="checkbox"/> Above-ground storage tanks are elevated?</p> <p><input type="checkbox"/> Below-ground storage tanks are designed to resist flotation / erosion?</p>
	<p>Enclosed area below DFE proposed (stairwells, garages, storage areas)?</p> <p><input type="checkbox"/> NO, area is free of obstructions; continue review.</p> <p><input type="checkbox"/> YES, enclosed by insect screening or lattice.</p> <p><input type="checkbox"/> YES, applicant has provided signed and sealed documentation of breakaway wall design.</p> <p><input type="checkbox"/> YES, design not documented. Advise applicant to obtain signed and sealed documentation of breakaway wall design from registered design professional.</p> <p><input type="checkbox"/> YES, flood damage-resistant materials specified.</p> <p><input type="checkbox"/> YES, utilities <u>not</u> penetrating or attached to breakaway walls.</p>
	<p><input type="checkbox"/> Record permit in log of flood hazard area permits.</p> <p><input type="checkbox"/> Make sure that all necessary documents are in the file.</p> <p style="text-align: center;">• • •</p> <p><input type="checkbox"/> Issue Permit and transfer file to Inspections.</p>

PERMIT APPLICATION REVIEW COMPLETED BY: _____ DATE: _____

- ISSUE PERMIT approved by: _____
- DENY PERMIT approved by: _____

**SPECIAL FLOOD
HAZARD AREA**

**INSPECTION CHECKLIST
NEW CONSTRUCTION,
WORK ON EXISTING BUILDINGS,
SI/SD, CONNECTED ADDITIONS
(FBC, B and FBC, R)**

ZONE A

Building Permit Number:	
Initial & Date	Inspection Steps
	Before site inspection: <input type="checkbox"/> REVIEW permit file before going in the field. <input type="checkbox"/> ASK permit reviewer questions to understand requirements.
	Measure stake out distances from waterway or landmark. Is development in the right place? Is fill the specified distance from waterway or landmark? <input type="checkbox"/> NO, take enforcement action to correct problems.
	Foundation / Lowest Floor Inspection: Permittee submitted Elevation Certificate? <input type="checkbox"/> YES, elevation of lowest floor checked during framing or foundation inspection after lowest floor is in place and prior to further vertical construction. <input type="checkbox"/> NO, require permittee to submit Elevation Certificate.
	Electrical, mechanical, plumbing, heating / air conditioning components elevated? <input type="checkbox"/> YES. <input type="checkbox"/> NO, take enforcement action to correct problems.
	For enclosures below the DFE (including crawl spaces): Is enclosure at or above grade on at least one entire side? Are flood damage-resistant materials used? Does use of enclosure appear to be limited to parking, building access, or limited storage (and crawlspace)? Are flood openings no more than 12" above interior / exterior grade? Are there enough flood openings (based on net open area provided by the flood openings or certification of engineered openings), are the openings on at least two sides and do they allow automatic entry / exit of floodwater (air vents disabled in open position and not designed for seasonal covers)? <input type="checkbox"/> YES. <input type="checkbox"/> Building does not have enclosure below the lowest floor. <input type="checkbox"/> NO, take enforcement action to correct problems.
	Final Inspection – Elevated Building: Permittee submitted as-built Elevation Certificate and review of document indicates it is correctly and fully completed? <input type="checkbox"/> YES, perform final inspection; maintain copy of documentation of final elevations in permanent records. <input type="checkbox"/> NO, require permittee to submit as-built Elevation Certificate and perform final inspection.
	Final Inspection – Dry Floodproofed Building. If removable shields, see ASCE 24 (Section 6.2.3 Limits on human intervention). Shields clearly marked for installation?
	Other Notes Based on Inspection:
	Issue Certificate of Occupancy only if final inspection shows compliance with flood hazard requirements. Certificate of Occupancy must contain a statement that documentation of the as-built lowest floor elevation has been provided and is retained in the records of the department. Put as-built Elevation Certificate and Floodproofing Certificate (if applicable) in permanent file.

FINAL INSPECTION COMPLETED BY: _____ DATE: _____

**SPECIAL FLOOD
HAZARD AREA**

**INSPECTION CHECKLIST
NEW CONSTRUCTION,
WORK ON EXISTING BUILDINGS,
SI/SD, CONNECTED ADDITIONS
(FBC, B and FBC, R)**

ZONE V

Building Permit Number:	
Initial & Date	Inspection Steps
	<p>Before site inspection:</p> <p><input type="checkbox"/> REVIEW permit file before going in the field.</p> <p><input type="checkbox"/> ASK permit reviewer questions to understand requirements.</p>
	<p>Measure stake out distances from landmark. Is development in the right place, and landward of the reach of mean high tide?</p> <p><input type="checkbox"/> NO, take enforcement action to correct problems.</p> <p><input type="checkbox"/> YES.</p>
	<p>Foundation / Lowest Floor Inspection: Permittee submitted Elevation Certificate?</p> <p><input type="checkbox"/> YES, elevation of the bottom of the lowest horizontal structural member of the lowest floor checked during framing or foundation inspection after lowest floor is in place and prior to further vertical construction.</p> <p><input type="checkbox"/> NO, require permittee to submit Elevation Certificate.</p>
	<p>For enclosures below DFE: Is enclosure with insect screening or lattice? Are walls breakaway, and no utilities attached to or penetrate breakaway walls? Are flood damage-resistant materials used? Does use of enclosure appear to be limited to parking, building access, or limited storage?</p> <p><input type="checkbox"/> YES.</p> <p><input type="checkbox"/> Building does not have enclosures.</p> <p><input type="checkbox"/> NO, take enforcement action to correct problems.</p>
	<p>Final Inspection: Permittee submitted as-built Elevation Certificate and review of document indicates it is correctly and fully completed?</p> <p><input type="checkbox"/> YES, perform final inspection; maintain copy of documentation of final elevations in permanent records.</p> <p><input type="checkbox"/> NO, require permittee to submit as-built Elevation Certificate and perform final inspection.</p>
	<p>Other Notes Based on Inspection:</p>
	<p>Issue Certificate of Occupancy only if final inspection shows compliance with flood hazard requirements. Certificate of Occupancy must contain a statement that documentation of the as-built lowest floor elevation has been provided and is retained in the records of the department. Put final Elevation Certificate in permanent file with V Zone Certificate.</p>

FINAL INSPECTION COMPLETED BY: _____ DATE: _____

SPECIAL FLOOD HAZARD AREA

BUILDING PERMIT APPLICATION SUPPLEMENT

Building Permit Number:	
Property Address:	Owner Name: Agent Name:
FIRM Panel Number:	FIRM Panel Date:
Flood Zone Designation: _____ In Floodway? Yes <input type="checkbox"/> No <input type="checkbox"/> <i>If yes, encroachment analysis required.</i> In CAZ/seaward of LiMWA? Yes <input type="checkbox"/> No <input type="checkbox"/> <i>If yes, determine if regulated as Zone V.</i> Seaward of CCCL? Yes <input type="checkbox"/> No <input type="checkbox"/> <i>If yes, more restrictive requirements prevail.</i> In CoBRA or OPA? Yes <input type="checkbox"/> No <input type="checkbox"/> <i>If yes, Federal flood insurance is not available.</i>	Base Flood Elevation: _____ feet _____ datum How determined? FIRM <input type="checkbox"/> FIS Water Surface Elevations <input type="checkbox"/> Unnumbered A Zone* <input type="checkbox"/> (BFE = 2 ft above grade unless evidence indicates deeper) Applicant Prepared Flood Study (attached) <input type="checkbox"/> FEMA Letter of Map Change (attached) <input type="checkbox"/> Additional Community Flood Hazard Data? Yes <input type="checkbox"/> No <input type="checkbox"/>
Community Higher Standards: (refer to local regulations and FBC amendments)	
Freeboard? Yes <input type="checkbox"/> _____ feet	
Enclosure? Yes <input type="checkbox"/> _____ (describe)	
CAZ? Yes <input type="checkbox"/> _____ (describe)	
Other? Yes <input type="checkbox"/> _____ (describe)	
<input type="checkbox"/> New Building Use and Occupancy: _____ Risk Category: _____ (see ASCE 24)	
<input type="checkbox"/> Existing Building. Use Substantial Improvement / Substantial Damage Worksheet	
DESIGN FLOOD ELEVATION:* _____ FEET _____ DATUM** *DFE = BFE if the community regulates based on FIRM. **Datum referenced in all design documents must be the same as FIRM datum (FBC, B Sec. 1603.1.7)	Proposed lowest floor elevation (A, AE, AH Zones): _____ feet above datum* <i>FEMA Form 086-0-33 Elevation Certificate required upon placement of lowest floor (prior to further vertical construction) and at final inspection. See FBC, B Sec. 107.3.5, Sec. 110.3 and Sec. 1612.5, and FBC, R322.1.10.</i> <hr/> Proposed lowest horizontal structural member (V, VE Zones, Coastal A Zones) : _____ feet above datum* <i>Florida Zone V Design Certificate required with plans. FEMA Form 086-0-33 Elevation Certificate required upon placement of lowest floor (prior to further vertical construction) and at final inspection. See FBC, B Sec. 107.3.5, Sec. 110.3 and Sec. 1612.5, and FBC, R322.3.6.</i> <hr/> Proposed dry floodproofed elevation: _____ feet above datum* <i>FEMA Form 086-0-34 Floodproofing Certificate required with plans. See. FBC, B Sec. 107.3.5 and Sec. 1612.5.</i>

Agreement by Property Owner or by Owner's Agent:

I agree to correct any construction deficiencies identified by inspection that are determined to be necessary to assure compliance with the applicable building permit, including elevation of the lowest floor, elevation of machinery and equipment servicing the building, and provisions applicable to any enclosures below the elevated building, including crawl/underfloor spaces. I agree to have the NFIP Elevation Certificate (FEMA Form 086-0-33) completed and signed by a Florida licensed professional surveyor and to submit it as required by the Florida Building Code. I agree to have any deficiencies in the Elevation Certificate corrected.

Date: _____ Signature: _____
Owner/Owner's Agent

SPECIAL FLOOD HAZARD AREA

SUBSTANTIAL IMPROVEMENT / SUBSTANTIAL DAMAGE WORKSHEET

Building Permit Number:		
<p>The determination of whether proposed work is Substantial Improvement or repair of Substantial Damage is made based on all proposed work. Complete all fields below that apply.</p> <p>Documentation to support stated cost estimates may be required.</p> <p>Check with the Building Department whether the community tracks accumulated repairs, alterations, additions and other improvements over time. Community-specific requirements may apply (e.g. cumulative costs over period of time).</p>		
STRUCTURE VALUE*	Source: Property Assessment <input type="checkbox"/> (includes factor of _____) Attached Appraisal <input type="checkbox"/> *use market value before improvement or before damage occurred	\$ _____ (A)
REPAIRS <i>FBC, EB Ch. 5</i> <i>Flood Damage?</i> Yes <input type="checkbox"/> No <input type="checkbox"/>	Describe work needed to repair to pre-damaged condition: Cost* to repair to pre-damaged condition:	\$ _____ (B)
ALTERATIONS <i>FBC, EB Ch.6-8</i>	Describe alterations: Cost* of alterations:	\$ _____ (C)
ADDITIONS <i>FBC, EB Ch. 11</i>	Describe additions: Horizontal Addition? Yes <input type="checkbox"/> No <input type="checkbox"/> Structurally interconnected? Yes <input type="checkbox"/> No <input type="checkbox"/> Vertical Addition? Yes <input type="checkbox"/> No <input type="checkbox"/> Foundation work? Yes <input type="checkbox"/> No <input type="checkbox"/> Cost* of additions:	\$ _____ (D)
HISTORIC BUILDING <i>FBC, EB, Ch. 11</i>	Does structure currently meet definition at FBC, EB Ch. 11 and Sec. 1102. Yes <input type="checkbox"/> No <input type="checkbox"/> After the proposed work is completed, will the building continue to meet the definition at FBC, EB Ch. 11? Yes <input type="checkbox"/> No <input type="checkbox"/>	If "yes" to both , proposed work is not considered substantial improvement. If "no", complete form.
Cost to correct existing cited health, sanitary, safety code violations (attach citations)		\$ _____ (E)
CALCULATING RATIO	$\left(\frac{B + C + D - E}{A} \right) \times 100$	_____ % (F)
DETERMINATION	<p style="text-align: center;">FOR OFFICE USE ONLY</p> <p>Check all that apply in accordance with FBC, EB, any technical amendments thereto, and the local floodplain management ordinance.</p> <p><input type="checkbox"/> Building is Historic Structure and will retain historic designation after proposed work is completed; work is not considered "substantial improvement."</p> <p><input type="checkbox"/> Estimates of costs reviewed and accepted</p> <p><input type="checkbox"/> Estimates of costs returned for more information</p> <p><input type="checkbox"/> Appraisal, if provided, reviewed and deemed to represent building</p> <p><input type="checkbox"/> Ratio of costs to market value does not constitute "substantial improvement."</p> <p><input type="checkbox"/> Horizontal addition is not structurally interconnected and does not constitute "substantial improvement" of base building</p> <p style="margin-left: 20px;"><input type="checkbox"/> Addition must be compliant with FBC, EB and FBC, B Section 1612.</p> <p style="margin-left: 20px;"><input type="checkbox"/> Addition must be compliant with FBC, EB and FBC, R Section R322.</p>	



Performance Measure 4

Verify accurate completion of all Elevation Certificates before vertical construction and prior to issuance of Certificates of Occupancy

FEMA Elevation Certificate (with instructions and building diagrams):
<https://www.fema.gov/media-library/assets/documents/160?id=1383>



Performance Measure 5

Disseminate letters annually to utility companies advising that new or replacement tanks must be elevated or anchored, and heating, ventilation and air conditioning (HVAC) equipment must be elevated above the Base Flood Elevation (BFE)

INSERT COMMUNITY LETTERHEAD

{DATE}

{NAME OF MANAGER}
{COMPANY NAME}
{ADDRESS 1}
{ADDRESS 2}

RE: Installation of Gas or Liquid Storage Tanks in Special Flood Hazard Areas

Attention: Please read this notice carefully, your cooperation and response is requested.

Our community participates in the National Flood Insurance Program (NFIP) and enforces a local floodplain management ordinance. The ordinance is intended to require construction practices to minimize flood damage, minimize damage to utilities, and minimize public funds for response to and recovery from flood events. In addition to the ordinance, we enforce the Florida Building Code which governs the construction of flood-prone structures and buildings, as well as associated tanks, and mechanical, electrical and plumbing components.

The {City or County} is providing this notice as a reminder that new and replacement gas or liquid storage tanks installed in SFHAs must be properly elevated to or above the design flood elevation or properly anchored to resist hydrostatic and hydrodynamic forces. This notice advises your company that the {City or County} must issue permits for installation of all new gas or liquid storage tanks in special flood hazard areas in accordance with the {City or County's} floodplain management ordinance. This reminder is intended to provide you with basic information and resources and should not be considered a substitute for complying with the local ordinance or the *Florida Building Code*. Should you have questions, desire additional guidance, or obtain a permit application form, please see our website {website link} or you may contact our department at {contact information}.

Local, State and Federal Tank Installation Requirements: The {NAME OF COMMUNITY} code of ordinance {INSERT LOCAL CODE CITATION, IF ANY}, the 2015 Florida Building Code (FBC, FG 301.11) and the National Flood Insurance Program (44 CFR 60.3) requires that gas or liquid storage tanks, appliances, equipment and system installations shall be located at or above the design flood elevation in Special Flood Hazard Areas (SFHAs) where a base flood elevation number is provided (Zone AE), or at least 2 feet above the highest adjacent grade if a base flood elevation number is not specified on the community's Flood Insurance Rate Maps (FIRMs).

Alternatively, gas or liquid storage tanks, appliances, equipment and system installations are permitted to be located below the required flood elevation in Zone A and AE provided that they are designed and installed to prevent water from entering or accumulating within the components and to resist hydrostatic and hydrodynamic loads and stresses, including the effects of buoyancy, during the occurrence of flooding to the base flood elevation.

Tips for anchoring tanks in Zones A or AE:

- Attach tank to large concrete slab whose weight is great enough to resist the force of flood waters;
- Run straps over the tank and attach them to the concrete slab using turnbuckles;
- Anchor horizontal propane tank with four ground anchors connected across the top of the tank with metal straps;
- Anchor a vertical propane tank with two ground anchors set on opposite sides of the tank. Attach a strap from each anchor to the collar secured around top of the tank. Attach another metal strap connected from one anchor to the other through tank base. This is similar to anchoring a manufactured home and manufactured home installers may make such products available.

Tanks in Zone V or VE:

Above-ground, elevated tanks below the base flood elevation are not permitted in coastal high hazard areas Zone V or VE. Tanks are considered structures under the FBC, and tank-supporting structures must also meet the structure foundation requirements within that flood zone. Extend vent pipe, inlets or fill openings, and any outlets above the DFE to prevent water from contaminating tank contents, or they can be fitted with covers to prevent inflow or outflow. A threaded fill cap with a tight gasket is recommended for home fuel tanks to prevent outflow. Help protect home and business owners by reminding them to shut off supply lines to equipment when flood or tidal surge warnings are issued.

Permits Required: If a structure is located in a SFHA, the contractor or property owner must apply and receive a permit prior to installation of new gas or liquid storage appliances, equipment and system. Applications for a permit can be obtained and submitted at [{LOCATION}](#), or online at [{INSERT WEBPAGE}](#).

Receiving a {City or County} Flood Zone Determination: Contractors or property owners can obtain a flood zone determination and base flood elevations for a property by visiting [{COMMUNITY LOCATION}](#), and [{INSERT INSTRUCTIONS}](#). Alternatively, contractors or property owners may determine required elevations for installation of gas or liquid storage appliances, equipment and systems as described below.

Identifying Required Elevations: FIRMs for [{NAME OF COMMUNITY}](#) can be accessed at FEMA's Mapping Service Center Website: <https://msc.fema.gov/> or [{LOCATION IN COMMUNITY WHERE MAPS ARE AVAILABLE}](#). Once your company or the contractor has located a specific property on the community's respective FIRM panel, your company or the contractor should determine whether the structure is in a flood zone, and whether a design flood elevation has been provided (freeboard).

In the example below, Building 1 (outlined in red) is located in a Zone A and Building 2 is located in a Zone AE. Building 1 does not have a specified flood depth number, and Building 2 has an elevation requirement of 91.3 feet above sea level. Since Building 1 does not have a specified elevation number provided on the FIRM, all gas or liquid storage appliances, equipment and system should be installed at least 2 feet above the highest adjacent grade at this building. Since Building 2 does have a specified base flood elevation number, in this case

91.3 feet, all appliances, equipment and systems should be installed at or above an elevation of 91.3 feet above sea level {plus X feet if community has freeboard}.

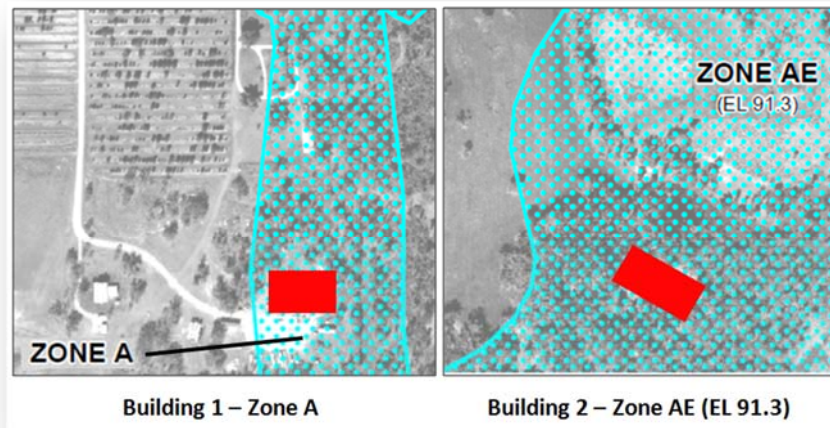

If your company or property owner is unsure about elevation or anchoring requirements pertaining to a structure or its utilities, your company or the contractor must contact the {City's or County's} {DEPARTMENT NAME} at {INSERT PHONE}, by email at {EMAIL ADDRESS}, or in person at {ADDRESS LOCATION}.

Anchoring Vertical Tanks, example: As shown in the figure below (next page), vertical tanks must be secured with a minimum of two ground anchors. Set each anchor on opposite sides of vertical tanks. Attach a strap from each anchor to the collar secured around top of the tank. Another metal strap should be passed through and under the tanks base connected from one anchor to the other. The ground anchors and straps described below are the same type of products that are required by building codes to tie down mobile homes.

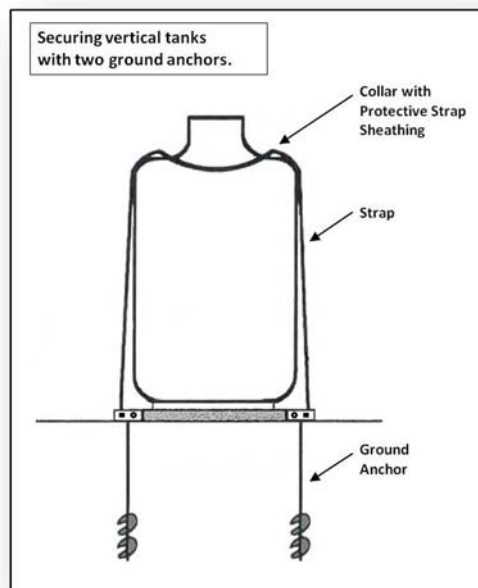

Anchoring Horizontal Tanks, example: The attached guidance document from FEMA (April 2011) entitled “Anchor Fuel Tanks,” provides a diagram (see page 2 of 3) of an inexpensive way to secure a horizontal propane tank with four ground anchors connected across the top of the tank with metal straps.

Request Follow-Up Action: The {City or County} requests that your company provide a brief response to this notice, acknowledging that you have received, reviewed and intend to comply with this guidance to ensure compliance with the {City’s or County’s} floodplain ordinance. Please keep a copy of this notice and your company’s response for your records. We thank you in advance for your cooperation and assistance in ensuring that our community is diligent in preventing loss of building equipment due to flood hazards.

Sincerely,

{COMMUNITY OFFICIAL’S SIGNATURE}

{OFFICIAL’S NAME, OFFICIAL’S TITLE}

Attachment: FEMA (April 2011) *Anchor Fuel Tanks*.

Anchor Fuel Tanks



FEMA

PROTECTING YOUR PROPERTY FROM FLOODING

Unanchored fuel tanks can be easily moved by flood waters, posing serious threats not only to you, others, and your property, but also to public safety and the environment. An unanchored tank outside your building can be driven into the building walls by flood waters, or it can be swept downstream, damaging other houses. When an unanchored tank in your basement is moved by flood waters, the supply line can tear free and your basement can be contaminated by oil. Even a buried tank can be pushed to the surface by the buoyant effect of soil saturated by water.

As shown in the first figure, one way to anchor a fuel tank is to attach it to a large concrete slab whose weight is great enough to resist the force of flood waters. This method can be used for all tanks above ground, both inside and outside your property. You can also anchor an outside tank by running straps over it and attaching them to the concrete slab by using turnbuckles.

Propane is stored in pressurized vessels as liquefied petroleum gas (LPG), which can be extremely volatile and potentially explosive if the tank is ruptured and the escaping LPG is ignited by a spark. As shown in the second figure (next page), an inexpensive way to secure a horizontal outside propane tank is to install four ground anchors connected across the top of the tank with metal straps. Secure a vertical tank (120-gallon, 420 lb. size) with two ground anchors. Set each anchor on opposite sides of vertical tank. Attach a strap from each anchor to the collar secured around top of the tank. Attach another metal

strap connected from one anchor to the other through tank base. The ground anchors and straps described below are the same products that are required by building codes to tie down mobile homes. These products are available from suppliers and installers that service the manufactured housing industry. Similar products can be used to anchor an outside heating oil tank. As is illustrated in the third figure (next page), one way to secure the oil tank is by running straps over it and attaching them to ground anchors.

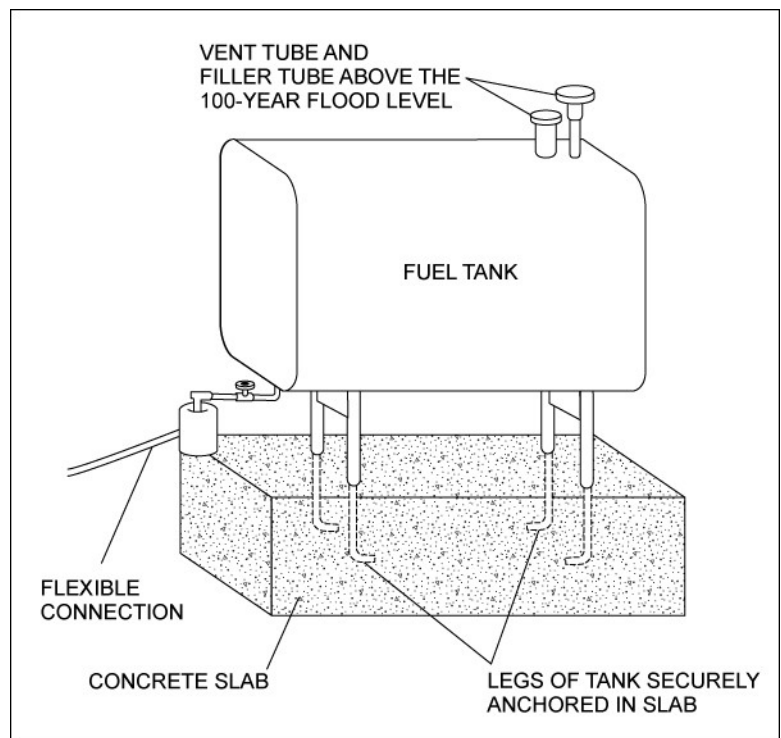

Anchoring a fuel tank.

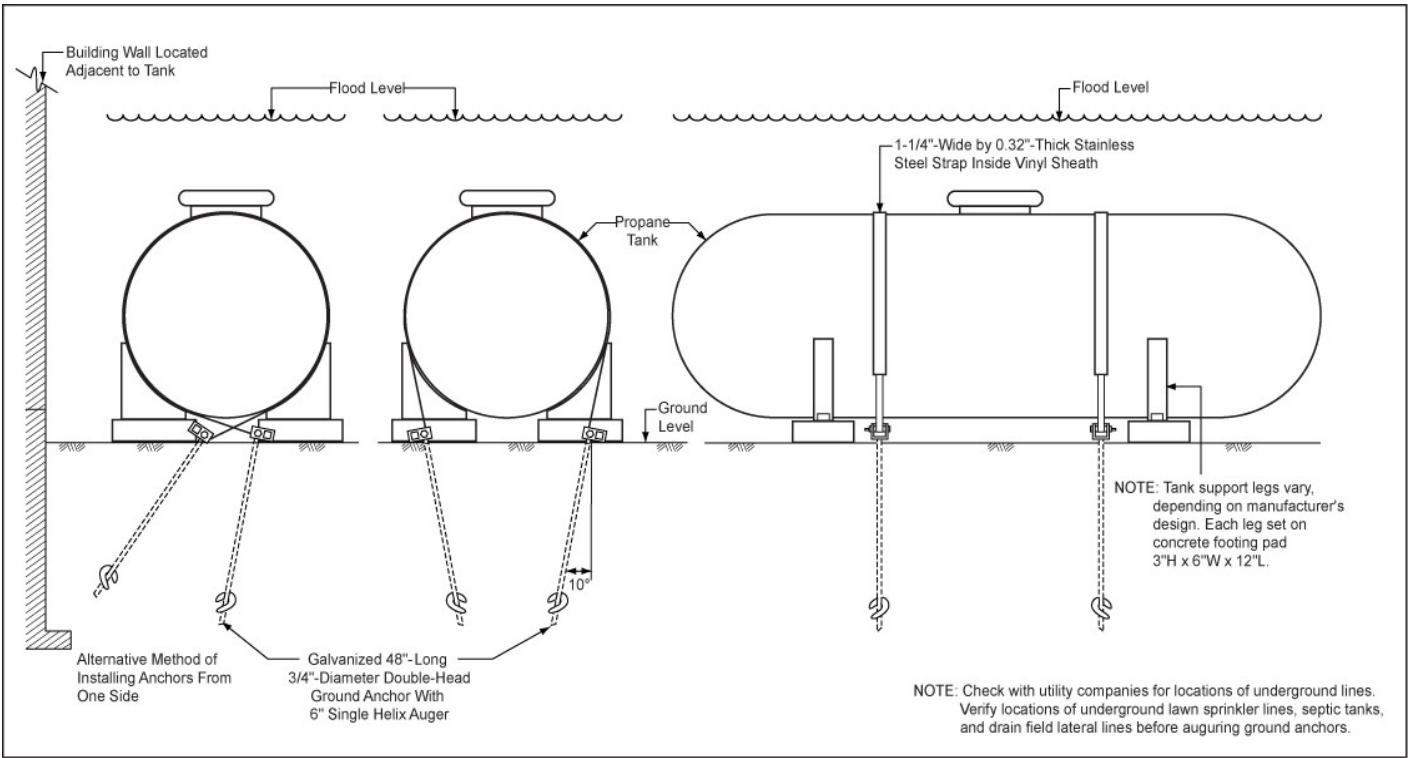

Anchoring an outside propane tank.

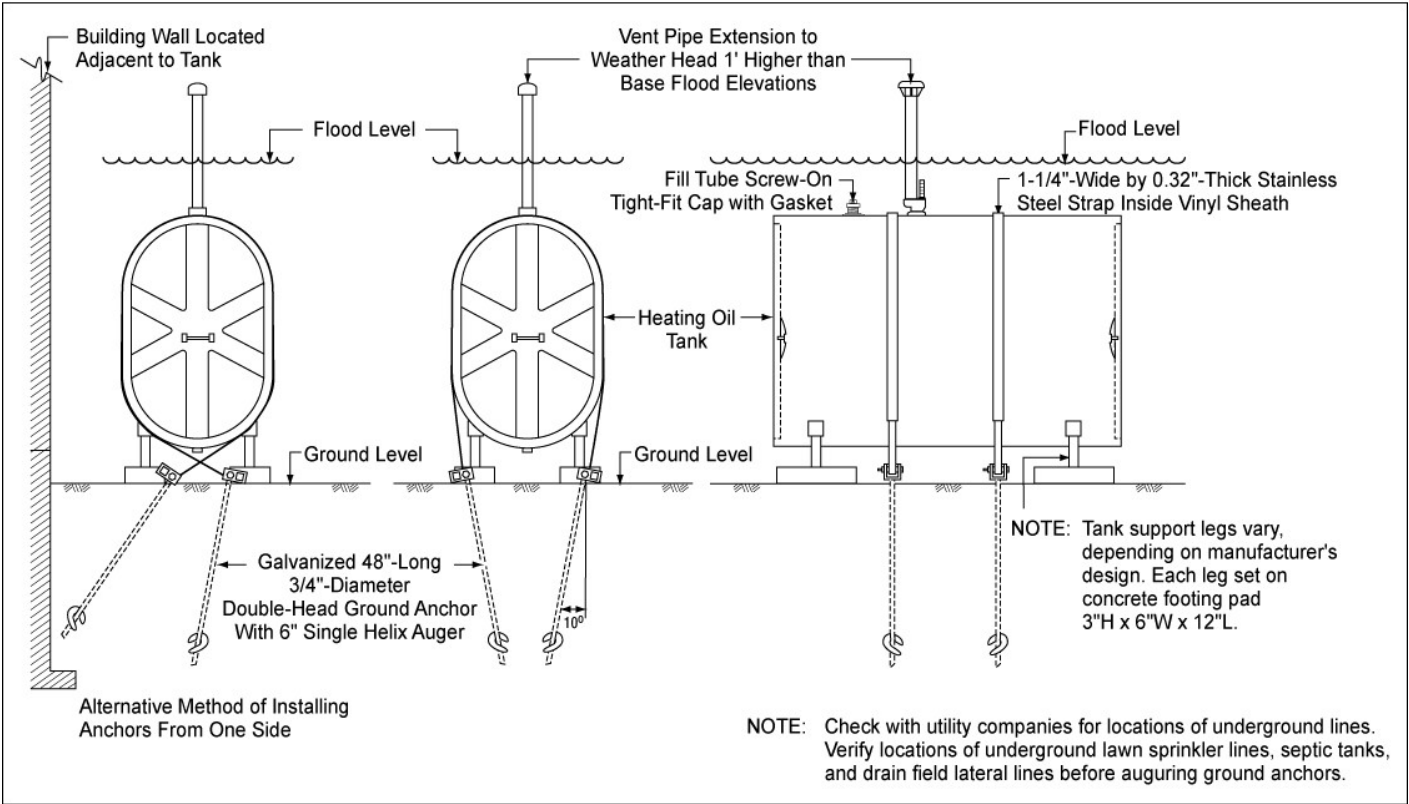

Anchoring an outside heating oil tank.

BENEFITS OF UTILIZING THIS MITIGATION STRATEGY

- Helps to prevent damage and contamination to a structure and neighboring structures
- Helps to protect public health and safety, as well as those of the structure's occupants, in addition to protecting the environment

TIPS

Keep these points in mind when you anchor a fuel tank:

- ✓ If you prefer not to do this work yourself, you can have a handyman or contractor anchor your tank.
- ✓ Extend all filling and ventilation tubes above the 100-year flood level so that flood waters cannot enter the tank.
- ✓ Close all connections when flood warnings are issued.

ESTIMATED COST

Anchoring a 1,000-gallon fuel tank to a concrete base will cost approximately \$300 to \$500.

OTHER SOURCES OF INFORMATION

FEMA 259, *Engineering Principles and Practices for Retrofitting Flood Prone Residential Buildings*, January 1995, <http://www.fema.gov/library/viewRecord.do?id=1645>. (New FEMA 259 will be available in the Fall of 2011.)

FEMA 348, *Protecting Building Utilities from Flood Damage*, Chapter 3, November 1999, <http://www.fema.gov/library/viewRecord.do?id=1750>.

FEMA P-499, *Home Builder's Guide to Coastal Construction*, "Protecting Utilities," Technical Fact Sheet No. 8.3, December 2010, <http://www.fema.gov/library/viewRecord.do?id=2138>.

FEMA 481, *Anchoring Home Fuel Tanks* (DVD), <http://www.fema.gov/library/viewRecord.do?id=2021>.

FEMA, *Anchoring Home Fuel Tanks* (Video), <http://www.youtube.com/watch?v=qVTSWXnLmC4>

To view and download FEMA publications visit the FEMA Library at <http://www.fema.gov/library>. To obtain FEMA publications please call 1-800-480-2520 or fax 1-240-699-0525 Monday through Friday 8 a.m. – 5 p.m. EST. You may also email your request to FEMA-Publications-Warehouse@dhs.gov. Please provide the title, item number, short number, and quantity of each publication, along with your name, address, zip code, and daytime telephone number.

{DATE}

{NAME OF MANAGER}
{COMPANY NAME}
{ADDRESS 1}
{ADDRESS 2}

RE: Installation of Mechanical and Electric Systems in Special Flood Hazard Areas

Attention: Please read this notice carefully, your cooperation and response is requested.

Our community participates in the National Flood Insurance Program (NFIP) and enforces a local floodplain management ordinance. The ordinance is intended to require construction practices to minimize flood damage, minimize damage to utilities, and minimize public funds for response to and recovery from flood events. In addition to the ordinance, we enforce the Florida Building Code which governs the construction of flood-prone structures and buildings, as well as associated mechanical, electrical and plumbing components.

The {City or County} is providing this notice as a reminder that new and replacement air conditioning compressors, ductwork and air handler units installed in SFHAs must be properly elevated to or above the design flood. This notice advises your company that the {City or County} must issue permits for installation of all new air conditioning systems in special flood hazard areas {and may be required to obtain a permit for replacement} in accordance with the {City or County's} floodplain management ordinance. This reminder is intended to provide you with basic information and resources and should not be considered a substitute for complying with the local ordinance or the *Florida Building Code*. Should you have questions, desire additional guidance, or obtain a permit application form, please see our website {website link} or you may contact our department at {contact information}.

Permits Required: If a structure is located in a SFHA, the contractor or property owner must apply and receive a permit prior to installation of a new mechanical, electrical and/or duct system {and may be required for replacement systems}. Applications for a permit can be obtained and submitted at {LOCATION} or online at {WEBPAGE ADDRESS}.

Receiving a {City or County} Flood Zone Determination: Contractors or property owners can obtain a flood zone determination and base flood or design flood elevations for a property by visiting {COMMUNITY LOCATION}, and {INSERT INSTRUCTIONS}. Alternatively, contractors or property owners may determine what elevations must be used for installation of mechanical and electrical systems as described below.

Local, State and Federal Installation Requirements: The {NAME OF COMMUNITY} code of ordinance {INSERT LOCAL CODE CITATION, IF ANY}, the 2015 Florida Building Code (FBC, R322.1.6) and the National Flood Insurance Program (44 CFR 60.3) requires that mechanical, electrical and duct systems shall be located at or above the design flood elevation in Special

Flood Hazard Areas (SFHAs) where a base flood elevation number is provided (Zones V, VE or AE), or at least 2 feet above the highest adjacent grade if a base flood elevation number is not specified on the community's Flood Insurance Rate Maps (FIRMs) {plus X feet if community has freeboard}.

Identifying Required Elevations: FIRMs for {NAME OF COMMUNITY} can be accessed at FEMA's Mapping Service Center Website: <https://msc.fema.gov/> or {LOCATION IN COMMUNITY WHERE MAPS ARE AVAILABLE}. Once the company or contractor has located a specific property on the community's respective FIRM panel, your company or the contractor should determine whether the structure is in a flood zone, and whether a design flood elevation has been provided (freeboard).

In the example below, Building 1 (outlined in red) is located in a Zone A and Building 2 is located in a Zone AE. Building 1 does not have a specified flood depth number, and Building 2 has an elevation requirement of 91.3 feet above sea level. Since Building 1 does not have a specified elevation number provided on the FIRM, all mechanical, electrical and duct systems should be installed at least 2 feet above the highest adjacent grade at this building. Since Building 2 does have a specified base flood elevation number, in this case 91.3 feet, all systems should be installed at or above an elevation of 91.3 feet above sea level.

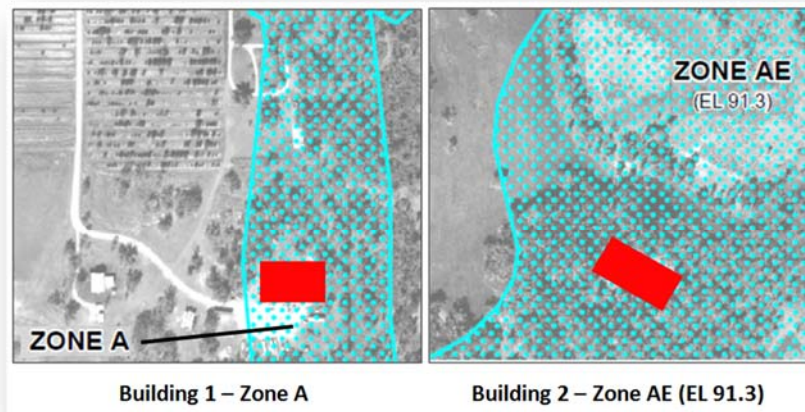

As a general rule, replacement compressors must be no lower than the Finished Floor Elevation (FFE) of the structure. If your company or the contractor is unsure about elevation requirements pertaining to a structure, your company or the contractor should contact the {City's or County's} {DEPARTMENT NAME} at {INSERT PHONE}, by email at {EMAIL ADDRESS}.

The {City or County} requests that you provide a brief response to this notice, acknowledging that you have received and reviewed it. Please keep a copy of this notice and your company's response for your records. We thank you in advance for your cooperation and assistance in ensuring that our community is diligent in preventing loss of equipment due to flood hazards.

Sincerely,

{COMMUNITY OFFICIAL'S SIGNATURE}



Performance Measure 6

Develop and implement “Substantial Improvement/Substantial Damage” determination procedures approved by the State Floodplain Management Office and retain permanent records of determinations

Florida's Substantial Improvement and Substantial Damage Notice for Property Owners, Contractors, and Design Professionals

[This example is based on the NFIP definition for Substantial Improvement and Substantial Damage. Florida communities that adopt modifications to those definitions should amend this packet to reflect those modifications.]

TO: Property Owners, Contractors, and Design Professionals

FROM: **{Local Official, Community}**

SUBJECT: Notice for Work on Existing Buildings in Special Flood Hazard Areas
Substantial Improvement / Substantial Damage Worksheets

The *Florida Building Code* (FBC) requires all new buildings located in Special Flood Hazard Areas (SFHAs) (regulated floodplains) to have their lowest floors elevated to or above the Base Flood Elevation (BFE). The regulations also specify that **substantial improvement** of existing buildings (alterations, remodeling, rehabilitation, improvement, or addition) or buildings that have sustained **substantial damage** must be brought into compliance with the requirements for new construction. Please note that a building may be substantially damaged by any cause, including fire, flood, high wind, seismic activity, land movement, or neglect. It is important to understand all costs of improvements, and all costs to repair a substantially damaged building to its pre-damage condition, must be identified.

There are several aspects that must be addressed to achieve compliance with the flood hazard area requirements of the FBC. The requirements depend on several factors, including the flood zone at the property. The most significant compliance requirement is the lowest floor, as defined in the FBC, must be elevated to or above a specific elevation. Please plan to meet with this department to review your proposed project, to go over the requirements, and to discuss how to bring your building into compliance.

The *Florida Building Code* defines these terms:

Substantial damage means damage of any origin sustained by a structure whereby the cost of restoring the structure to its before-damaged condition would equal or exceed 50 percent of the market value of the structure before the damage occurred.

Substantial improvement means any repair, reconstruction, rehabilitation, alteration, addition, or other improvement of a building or structure, the cost of which equals or exceeds 50 percent of the market value of the structure before improvement or repair is started. If the structure has sustained substantial damage, any repairs are considered substantial improvement regardless of the actual repair work performed. The term does not, however, include either:

- (1) Any project for improvement of a structure to correct existing health, sanitary or safety code violations identified by the building official and that are the minimum necessary to assure safe living conditions.
- (2) Any alteration of a "historic structure" provided that the alteration will not preclude the structure's continued designation as a "historic structure."

To make the substantial improvement determination, or the substantial damage determination, this office compares the cost of the proposed improvement or repairs to the market value of the building (excluding land, accessory structures, and landscaping). If the resulting ratio equals or exceeds 50 percent, the existing building must be brought into compliance with the flood hazard area requirements for new buildings.

$$\frac{\text{Cost of Improvement or Cost to Repair to Pre-Damage Condition}}{\text{Market Value of Building}} \geq 50\%$$

Please note:

- You must provide an estimate of the costs of all proposed improvements or repairs. If your building has been damaged, the cost estimate must include all work required to repair the building to its before-damage condition. The cost estimate must include all labor and materials. If the work will be done by a contractor, the contractor's overhead and profit must be included. If the work will be done by the owner or volunteers, market rates must be used to estimate the cost of materials and the value of labor. Attached to this notice is a list of costs that must be included and costs that are excluded. After we review the cost estimate, we may require that it be broken down to show all materials and labor estimates.
- We will estimate the market value of the building by using the most recent tax assessment value adjusted to approximate market value by a factor provided by the County Property Appraiser. Alternatively, you may provide an appraisal of the market value prepared by a qualified independent appraiser. The market value must be the value before any improvement are started or before any damage occurred.

If you have any questions regarding this information, please contact **{insert contact}**.

Attachments:

- Requirements for Applications for Permits for Substantial Improvements and Repair of Substantial Damage
- Costs for Substantial Improvements and Repair of Substantial Damage
- Owner's Affidavit
- Contractor's Affidavit

Requirements for Applications for Substantial Improvement and Repair of Substantial Damage

Please contact _____ if you have questions about the Substantial Improvement and Substantial Damage requirements. Your building may have to be brought into compliance with the floodplain management requirements for new construction.

Applications for permits to work on existing buildings that are located in Special Flood Hazard Areas must include the following:

- Current photographs of the exterior (front, rear, sides)
- If your building has been damaged, include photographs of the interior and exterior; provide pre-damage photos of the exterior, if available
- Detailed description of the proposed improvement (rehabilitation, remodeling, addition, etc.) or repairs
- Cost estimate of the proposed improvement or the cost estimate to repair the damaged building to its before-damage condition
- Elevation certificate or elevation survey
- You may submit a market value appraisal prepared by a licensed professional appraiser or we will use the tax assessment value of the building
- Owner's affidavit (signed and dated)
- Contractor's affidavit (signed and dated)

Costs for Substantial Improvements Repair of Substantial Damage Items that must be included:

Items that must be included in the costs of improvement or costs to repair are those that are directly associated with the building. The following list of costs that must be included is not intended to be exhaustive, but characterizes the types of costs that must be included:

- Materials and labor, including the estimated value of donated or discounted materials and owner or volunteered labor
- Site preparation related to the improvement or repair (foundation excavation, filling in basements)
- Demolition and construction debris disposal
- Labor and other costs associated with demolishing, moving, or altering building components to accommodate improvements, additions, and making repairs
- Costs associated with complying with any other ordinance or code requirement that is triggered by the work, including costs to comply with the requirements of the Americans with Disabilities Act (ADA)
- Costs associated with elevating a structure to an elevation that is lower than the BFE
- Construction management and supervision
- Contractor's overhead and profit
- Sales taxes on materials
- Structural elements and exterior finishes, including:
 - Foundations (e.g., spread or continuous foundation footings, perimeter walls, chainwalls, pilings, columns, posts, etc.)
 - Monolithic or other types of concrete slabs
 - Bearing walls, tie beams, trusses
 - Joists, beams, subflooring, framing, ceilings
 - Interior non-bearing walls
 - Exterior finishes (e.g., brick, stucco, siding, painting, and trim)
- Structural elements and exterior finishes (cont.):
 - Windows and exterior doors
 - Roofing, gutters, and downspouts
 - Hardware
 - Attached decks and porches
- Interior finish elements, including:
 - Floor finishes (e.g., hardwood, ceramic, vinyl, linoleum, stone, and wall-to-wall carpet over subflooring)
 - Bathroom tiling and fixtures
 - Wall finishes (e.g., drywall, paint, stucco, plaster, paneling, and marble)
 - Built-in cabinets (e.g., kitchen, utility, entertainment, storage, and bathroom)
 - Interior doors
 - Interior finish carpentry
 - Built-in bookcases and furniture
 - Hardware
 - Insulation
- Utility and service equipment, including:
 - HVAC equipment
 - Plumbing fixtures and piping
 - Electrical wiring, outlets, and switches
 - Light fixtures and ceiling fans
 - Security systems
 - Built-in appliances
 - Central vacuum systems
 - Water filtration, conditioning, and recirculation systems

Items that may be excluded:

Items that can be excluded are those that are not directly associated with the building. The following list characterizes the types of costs that may be excluded:

- Clean-up and trash removal
- Costs to temporarily stabilize a building so that it is safe to enter to evaluate required repairs
- Costs to obtain or prepare plans and specifications
- Land survey costs
- Permit fees and inspection fees
- Carpeting and recarpeting installed over finished flooring such as wood or tiling
- Outside improvements, including landscaping, irrigation, sidewalks, driveways, fences, yard lights, swimming pools, pool enclosures, and detached accessory structures (e.g., garages, sheds, and gazebos)
- Costs required for the minimum necessary work to correct existing violations of health, safety, and sanitary codes
- Plug-in appliances such as washing machines, dryers, and stoves

Owner's Affidavit: Substantial Improvement or Repair of Substantial Damage

Building Permit Application No.: _____

Property Address: _____

Parcel ID Number: _____

Owner's Name: _____

Owner's Address/Phone: _____

Contractor: _____

Contractor's License Number: _____

Date of Contractor's Estimate: _____

I hereby attest the description included in the building permit application for the work on the existing building that is located at the property identified above is all of the work that will be done, including all improvements, alterations, rehabilitation, remodeling, repairs, additions and any other form of improvement. I further attest that I requested the above-identified contractor to prepare a cost estimate for all of the work, including the contractor's overhead and profit.

I acknowledge that if, during the course of construction, I decide to add more work or to modify the work described, The Building Department will re-evaluate its comparison of the cost of work to the market value of the building to determine if the work is Substantial Improvement. Such re-evaluation may require revision of the building permit and may subject the property to additional requirements.

I also understand I am subject to enforcement action and/or fines if inspection of the property reveals I have made or authorized repairs or improvements that were not included in the description of work and the cost estimate for that work that were the basis for issuance of a permit.

Owner's Signature: _____ Date: _____

Notarized:

Contractor's Affidavit: Substantial Improvement or Repair of Substantial Damage

Building Permit Application No.: _____

Property Address: _____

Parcel ID Number: _____

Owner's Name: _____

Owner's Address/Phone: _____

Contractor: _____

Contractor's License Number: _____

Date of Contractor's Estimate: _____

I hereby attest I have personally inspected the building located at the above-referenced address and discussed the nature and extent of the work requested by the owner, including all improvements, alterations, rehabilitation, remodeling, repairs, additions, and any other form of improvement.

At the request of the owner, I have prepared a cost estimate for all of the improvement work and repairs requested by the owner and the cost estimate includes, at a minimum, the cost elements identified by the Building Department that are appropriate for the nature of the work. If the work is repair of damage, I have prepared a cost estimate to repair the building to its pre-damage condition. I acknowledge that if, during the course of construction, the owner requests more work or modification of the work described in the application, a revised cost estimate must be provided to the Building Department, which will re-evaluate its comparison of the cost of work to the market value of the building to determine if the work is Substantial Improvement. Such re-evaluation may require revision of the building permit and may subject the property to additional requirements.

I also understand I am subject to enforcement action and/or fines if inspection of the property reveals I have made or authorized repairs or improvements that were not included in the description of work and the cost estimate for that work used as the basis for issuance of a permit.

Owner's Signature: _____ Date: _____

Notarized:

SPECIAL FLOOD HAZARD AREA

SUBSTANTIAL IMPROVEMENT / SUBSTANTIAL DAMAGE WORKSHEET

Building Permit Number:		
<p>The determination of whether proposed work is Substantial Improvement or repair of Substantial Damage is made based on all proposed work. Complete all fields below that apply.</p> <p>Documentation to support stated cost estimates may be required.</p> <p>Check with the Building Department whether the community tracks accumulated repairs, alterations, additions and other improvements over time. Community-specific requirements may apply (e.g. cumulative costs over period of time).</p>		
STRUCTURE VALUE*	Source: Property Assessment <input type="checkbox"/> (includes factor of _____) Attached Appraisal <input type="checkbox"/> *use market value before improvement or before damage occurred	\$ _____ (A)
REPAIRS <i>FBC, EB Ch. 5</i> <i>Flood Damage?</i> Yes <input type="checkbox"/> No <input type="checkbox"/>	Describe work needed to repair to pre-damaged condition: Cost* to repair to pre-damaged condition:	\$ _____ (B)
ALTERATIONS <i>FBC, EB Ch.6-8</i>	Describe alterations: Cost* of alterations:	\$ _____ (C)
ADDITIONS <i>FBC, EB Ch. 11</i>	Describe additions: Horizontal Addition? Yes <input type="checkbox"/> No <input type="checkbox"/> Structurally interconnected? Yes <input type="checkbox"/> No <input type="checkbox"/> Vertical Addition? Yes <input type="checkbox"/> No <input type="checkbox"/> Foundation work? Yes <input type="checkbox"/> No <input type="checkbox"/> Cost* of additions:	\$ _____ (D)
HISTORIC BUILDING <i>FBC, EB, Ch. 11</i>	Does structure currently meet definition at FBC, EB Ch. 11 and Sec. 1102. Yes <input type="checkbox"/> No <input type="checkbox"/> After the proposed work is completed, will the building continue to meet the definition at FBC, EB Ch. 11? Yes <input type="checkbox"/> No <input type="checkbox"/>	If "yes" to both , proposed work is not considered substantial improvement. If "no", complete form.
Cost to correct existing cited health, sanitary, safety code violations (attach citations)		\$ _____ (E)
CALCULATING RATIO	$\left(\frac{B + C + D - E}{A} \right) \times 100$	_____ % (F)
DETERMINATION	<p style="text-align: center;">FOR OFFICE USE ONLY</p> <p>Check all that apply in accordance with FBC, EB, any technical amendments thereto, and the local floodplain management ordinance.</p> <p><input type="checkbox"/> Building is Historic Structure and will retain historic designation after proposed work is completed; work is not considered "substantial improvement."</p> <p><input type="checkbox"/> Estimates of costs reviewed and accepted</p> <p><input type="checkbox"/> Estimates of costs returned for more information</p> <p><input type="checkbox"/> Appraisal, if provided, reviewed and deemed to represent building</p> <p><input type="checkbox"/> Ratio of costs to market value does not constitute "substantial improvement."</p> <p><input type="checkbox"/> Horizontal addition is not structurally interconnected and does not constitute "substantial improvement" of base building</p> <p style="margin-left: 20px;"><input type="checkbox"/> Addition must be compliant with FBC, EB and FBC, B Section 1612.</p> <p style="margin-left: 20px;"><input type="checkbox"/> Addition must be compliant with FBC, EB and FBC, R Section R322.</p>	



Performance Measure 7

On community websites, where feasible, provide digital Flood Insurance Rate Maps (DFIRMs) or links to DFIRMS and Elevation Certificates ECs

FEMA Elevation Certificate (with instructions and building diagrams):

<https://www.fema.gov/media-library/assets/documents/160?id=1383>

FEMA Map Service Center for link to DFIRMS:

<https://msc.fema.gov/portal/advanceSearch>

<https://msc.fema.gov/portal>

